

Data Sheet



Article number: 20343316

Description: E+G Handwheel
GN 322-160-K16-A

Measures

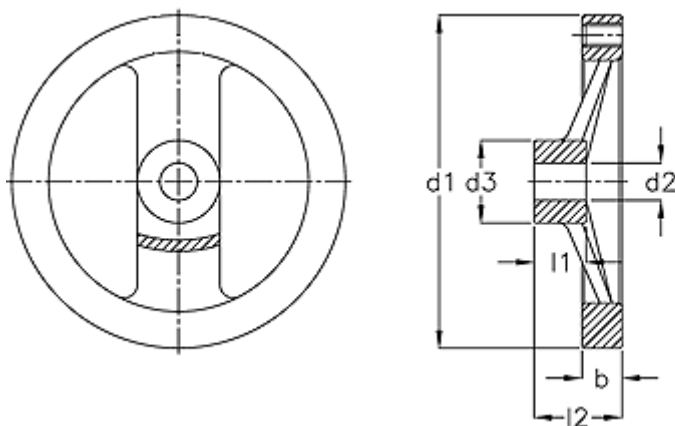

b = 18.0

d1 = 160

d2 H7 = 16

d3 = 36

l1 = 20

l2 = 39